

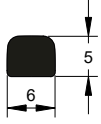

# ÖZEL TAKOZ LASTİKLERİ ÖZEL TAKOZ LASTİKLERİ

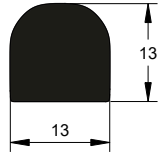
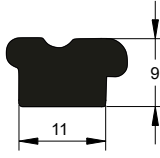
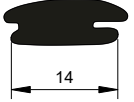
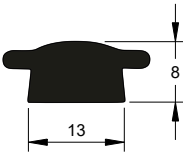
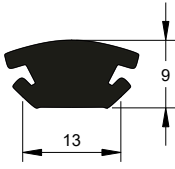
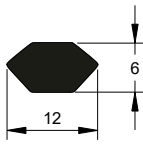
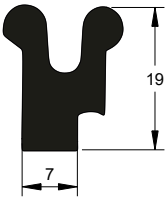
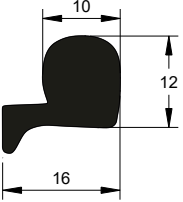
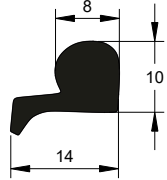
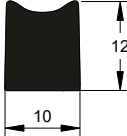
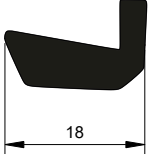
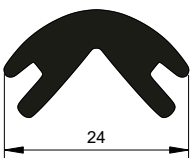

**İpekoğlu otomotiv**  
İPEKOĞLU OTOMOTİV

## ÖZEL TAKOZ LASTİKLERİ

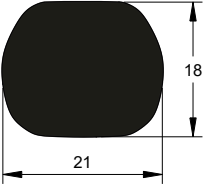
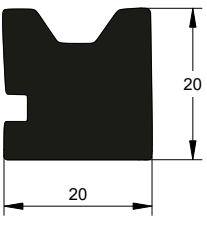
			
<b>PK CODE</b> 17-1001	<b>PK CODE</b> 17-1002	<b>PK CODE</b> 17-1003	<b>PK CODE</b> 17-1004
			
<b>PK CODE</b> 17-1005	<b>PK CODE</b> 17-1006	<b>PK CODE</b> 17-1007	<b>PK CODE</b> 17-1008
			
<b>PK CODE</b> 17-1009	<b>PK CODE</b> 17-1010	<b>PK CODE</b> 17-1011	<b>PK CODE</b> 17-1012
			
<b>PK CODE</b> 17-1013	<b>PK CODE</b> 17-1014	<b>PK CODE</b> 17-1015	<b>PK CODE</b> 17-1016

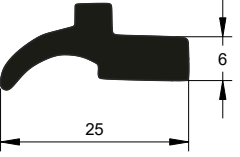
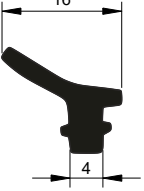
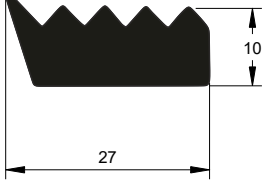
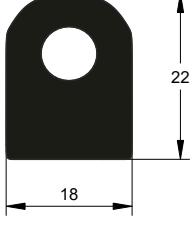
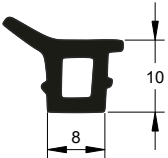
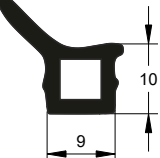
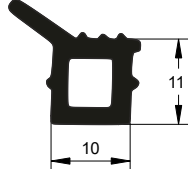
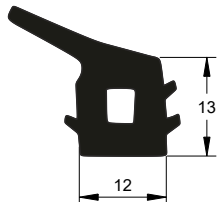
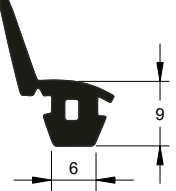
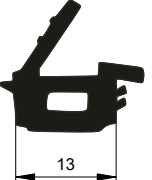
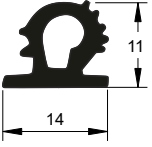
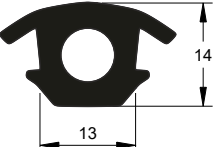
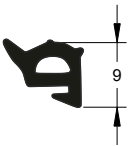
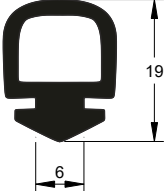
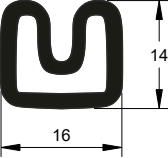
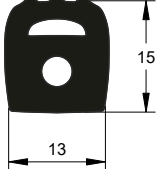

## ÖZEL TAKOZ LASTİKLERİ

			
<b>PK CODE</b> 17-1017	<b>PK CODE</b> 17-1018	<b>PK CODE</b> 17-1019	<b>PK CODE</b> 17-1020
			
<b>PK CODE</b> 17-1021	<b>PK CODE</b> 17-1022	<b>PK CODE</b> 17-1023	<b>PK CODE</b> 17-1024
			
<b>PK CODE</b> 17-1025	<b>PK CODE</b> 17-1026	<b>PK CODE</b> 17-1027	<b>PK CODE</b> 17-1028
			
<b>PK CODE</b> 17-1029	<b>PK CODE</b> 17-1030	<b>PK CODE</b> 17-1031	<b>PK CODE</b> 17-1032

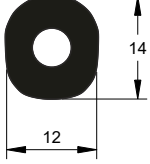
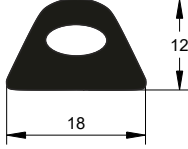
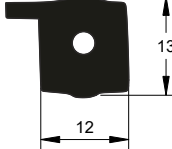
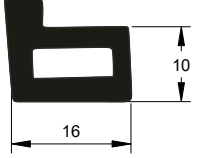
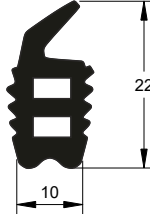
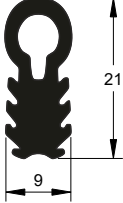
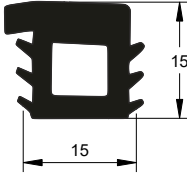
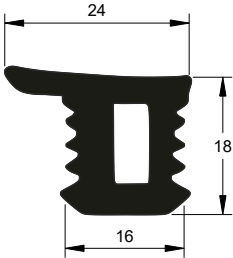
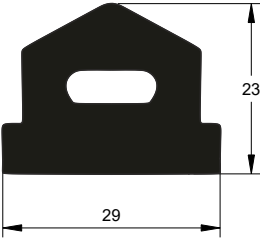
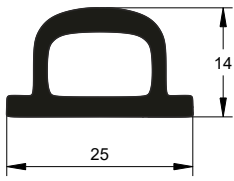
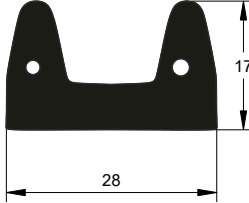
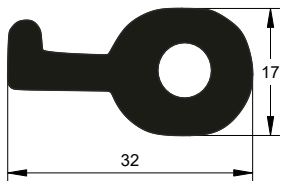
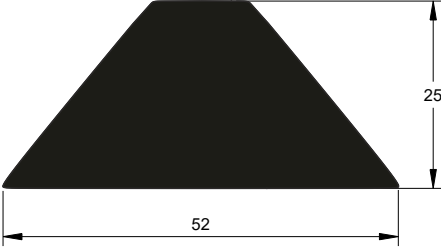
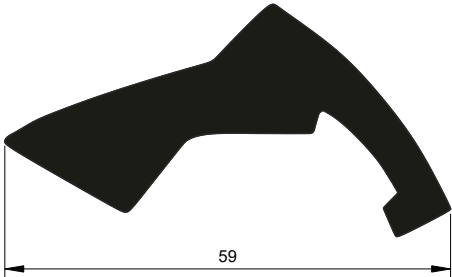
## ÖZEL TAKOZ LASTİKLERİ

			
<b>PK CODE</b> 17-1033	<b>PK CODE</b> 17-1034	<b>PK CODE</b> 17-1035	<b>PK CODE</b> 17-1036
			
<b>PK CODE</b> 17-1037	<b>PK CODE</b> 17-1038	<b>PK CODE</b> 17-1039	<b>PK CODE</b> 17-1040
			
<b>PK CODE</b> 17-1041	<b>PK CODE</b> 17-1042	<b>PK CODE</b> 17-1043	<b>PK CODE</b> 17-1044
			
<b>PK CODE</b> 17-1045	<b>PK CODE</b> 17-1046		

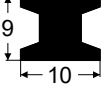
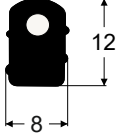
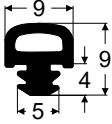
## ÖZEL TAKOZ LASTİKLERİ

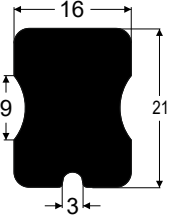
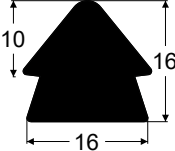
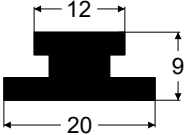
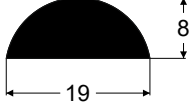
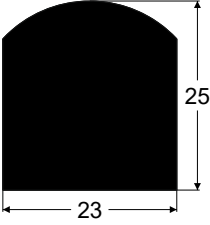
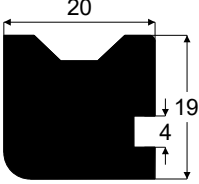
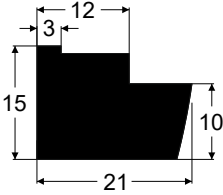
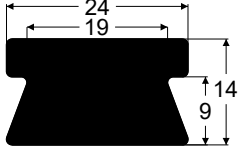
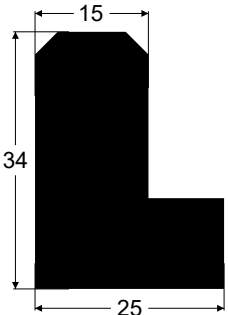
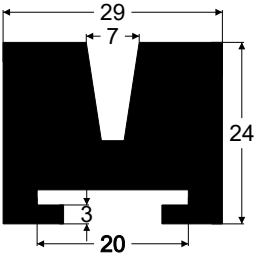
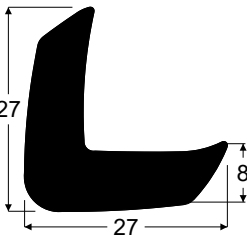
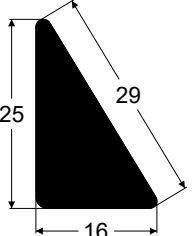
			
<b>PK CODE</b> 17-1047	<b>PK CODE</b> 17-1048	<b>PK CODE</b> 17-1049	<b>PK CODE</b> 17-1050
			
<b>PK CODE</b> 17-1051	<b>PK CODE</b> 17-1052	<b>PK CODE</b> 17-1053	<b>PK CODE</b> 17-1054
			
<b>PK CODE</b> 17-1055	<b>PK CODE</b> 17-1056	<b>PK CODE</b> 17-1057	<b>PK CODE</b> 17-1058
			
<b>PK CODE</b> 17-1059	<b>PK CODE</b> 17-1060	<b>PK CODE</b> 17-1061	<b>PK CODE</b> 17-1062

## ÖZEL TAKOZ LASTİKLERİ

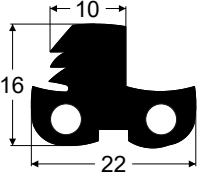
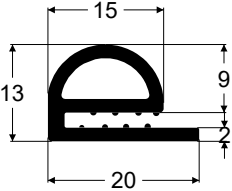
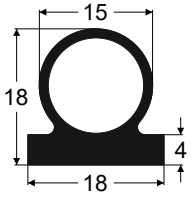
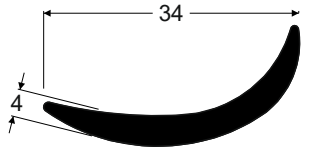
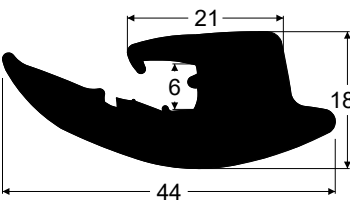
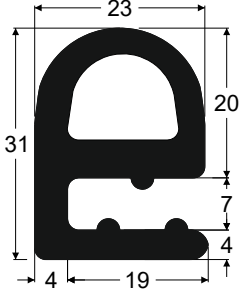
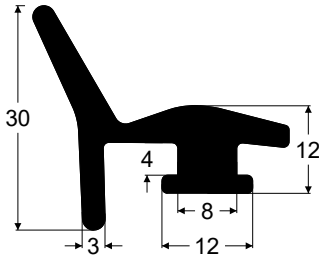
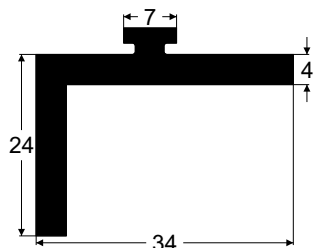
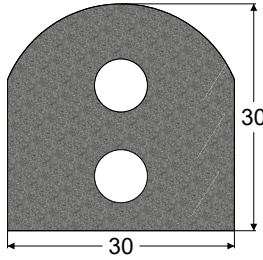
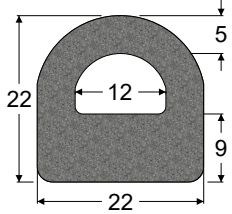
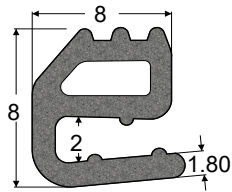
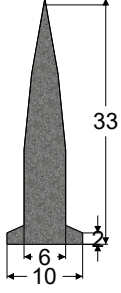
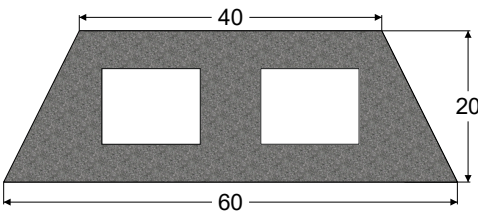
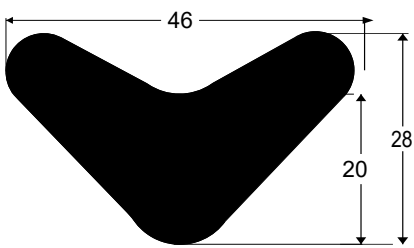
			
<b>PK CODE</b> 17-1063	<b>PK CODE</b> 17-1064	<b>PK CODE</b> 17-1065	<b>PK CODE</b> 17-1066
			
<b>PK CODE</b> 17-1067	<b>PK CODE</b> 17-1068	<b>PK CODE</b> 17-1069	<b>PK CODE</b> 17-1070
			
<b>PK CODE</b> 17-1071	<b>PK CODE</b> 17-1072	<b>PK CODE</b> 17-1073	<b>PK CODE</b> 17-1074
			
<b>PK CODE</b> 17-1075	<b>PK CODE</b> 17-1076		

## ÖZEL TAKOZ LASTİKLERİ

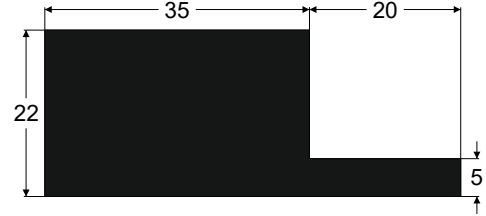
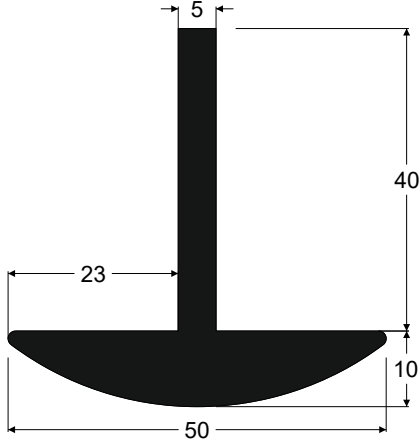

**PK CODE** 17-1077

**PK CODE** 17-1078

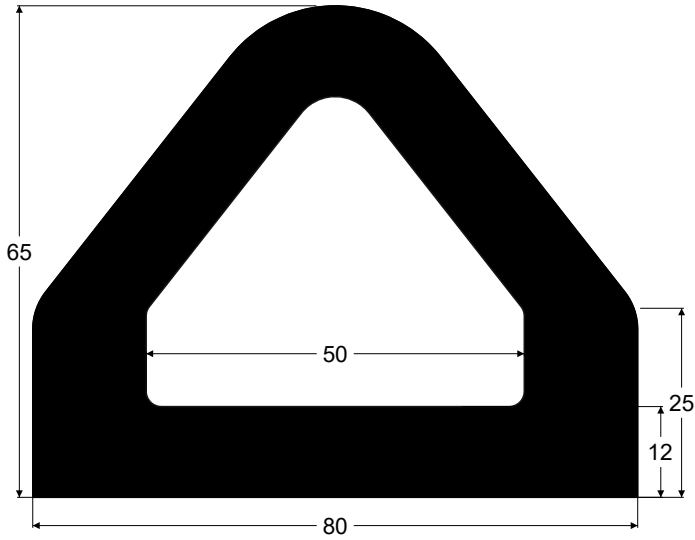

**PK CODE** 17-1079

**PK CODE** 17-1080

**PK CODE** 17-1081

**PK CODE** 17-1082

**PK CODE** 17-1083

**PK CODE** 17-1084





**Ipekoğlu Otomotiv**  
KAUÇUK PLASTİK İNŞAAT GIDA VE TARIM ÜRL. SAN. TİC. LTD. ŞTİ.

Tel: +90 332 239 02 33 pbx Fax: +90 332 239 05 62

K.O.S. Reisköy Caddesi İnsu Sokak No: 1

Selçuklu - KONYA / TÜRKİYE

e-mail: [ipekoglu@ipekoglu.com.tr](mailto:ipekoglu@ipekoglu.com.tr)

[www.ipekoglu.com.tr](http://www.ipekoglu.com.tr)